





	8.0x30 	4.0x25 	
A1	B	D	G	M1
6	12	32	4	4
				
O	B1	X1	X	
20	1	20	12	





**1**

8.0x30	
	D
2	

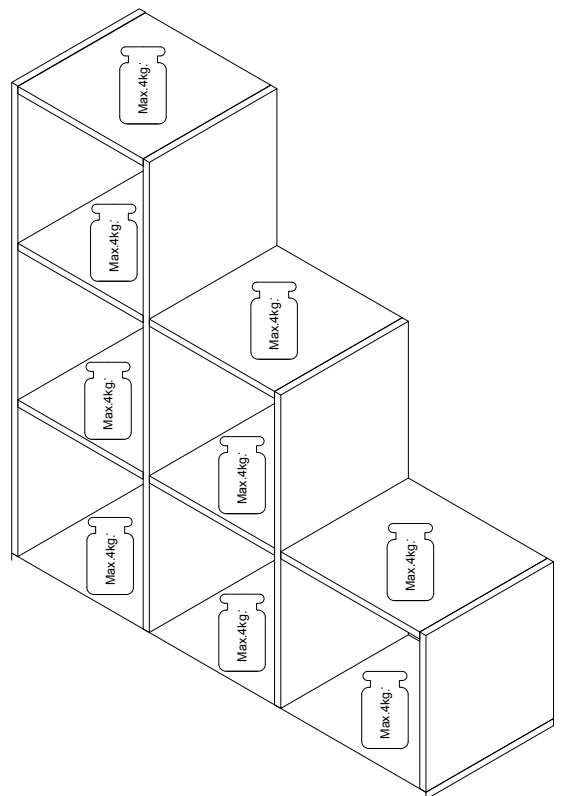
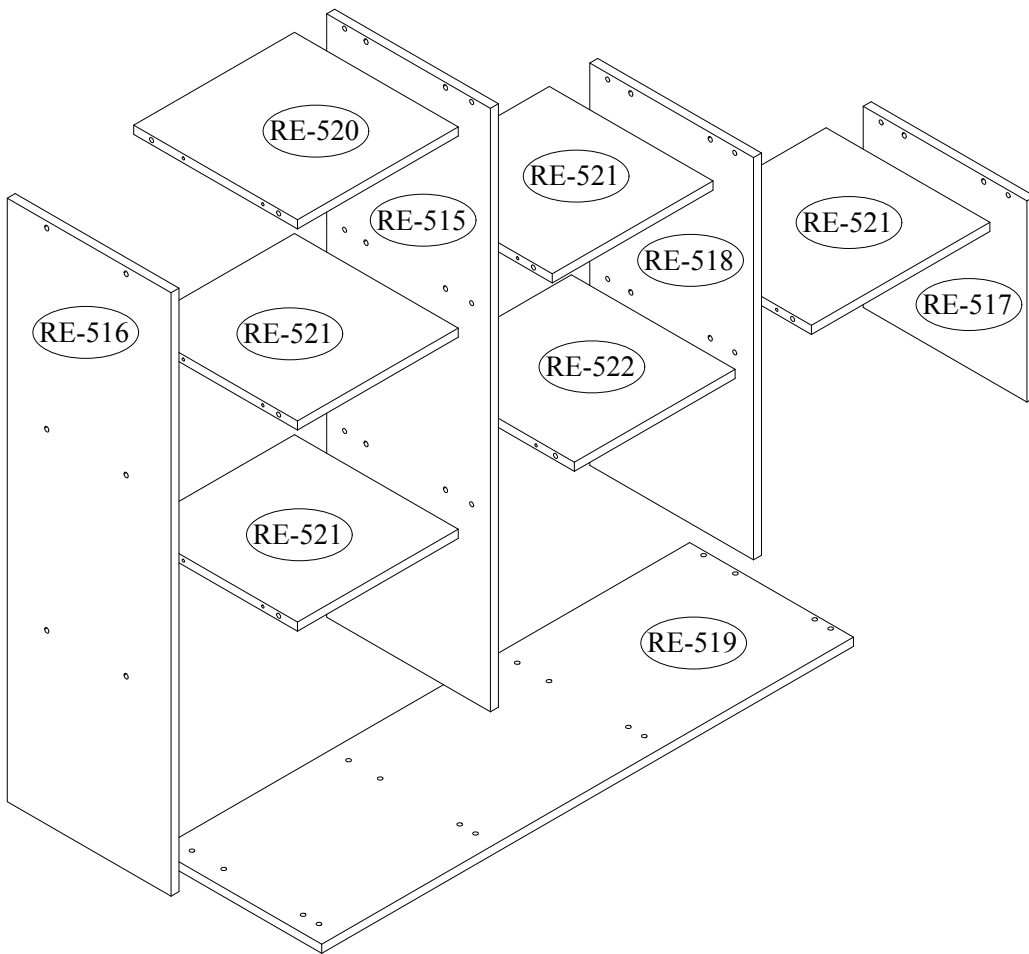
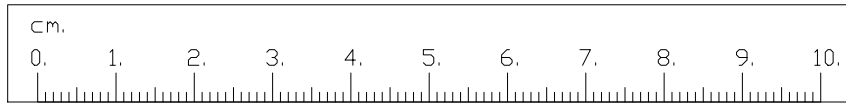
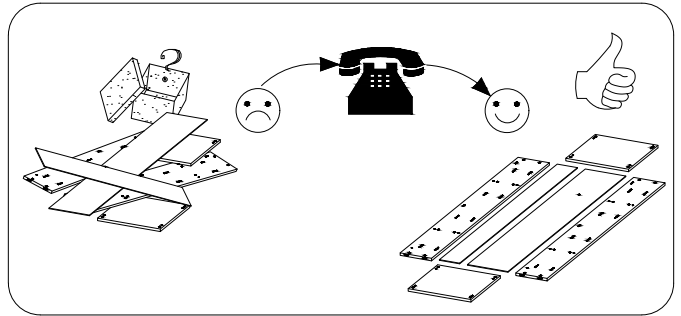
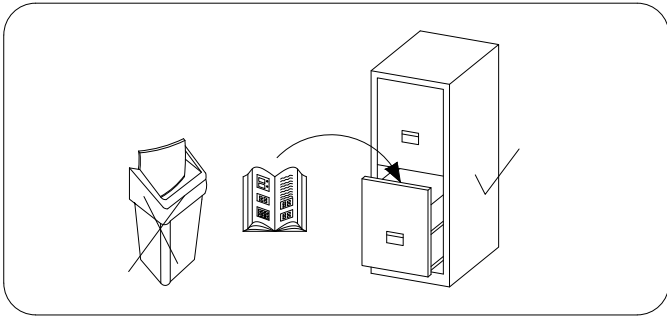
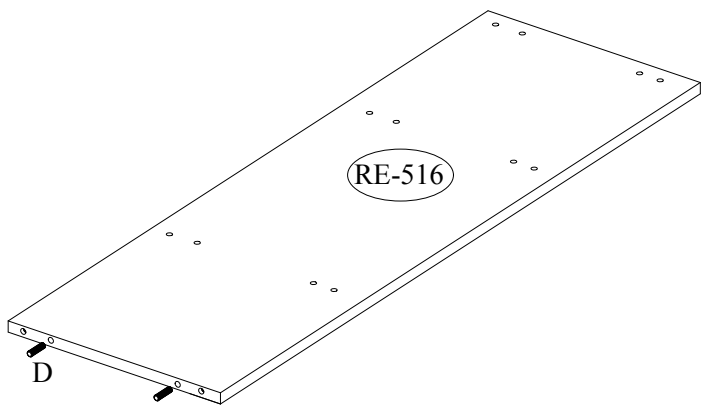
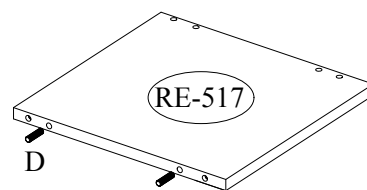
**2**

8.0x30	
	D
2	

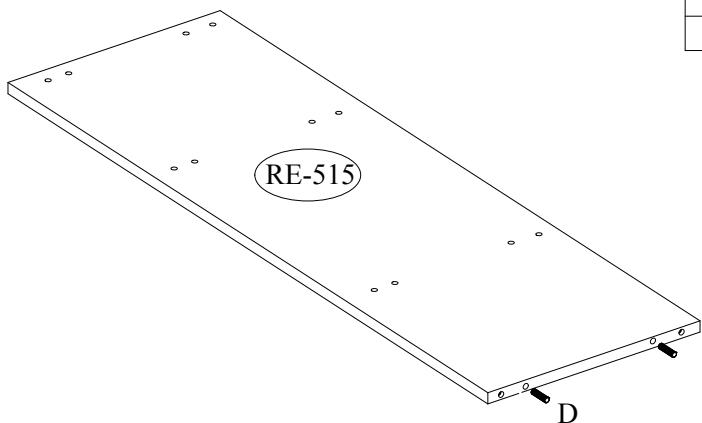
**3**

8.0x30	
	D
2	

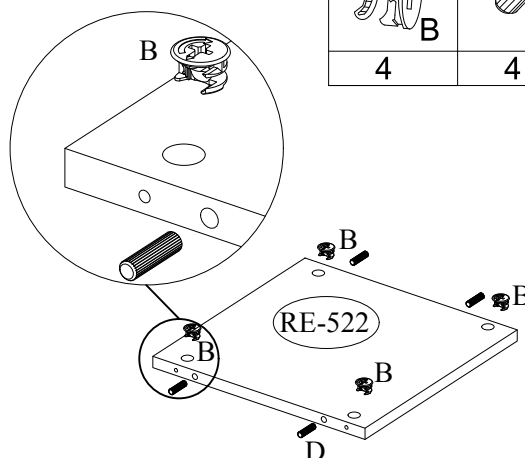
**4**

	8.0x30
B	D
4	4

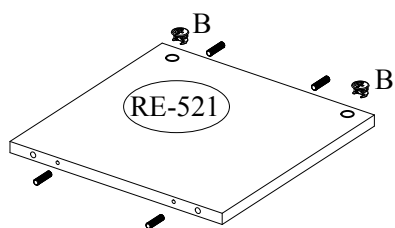
**5****4x**

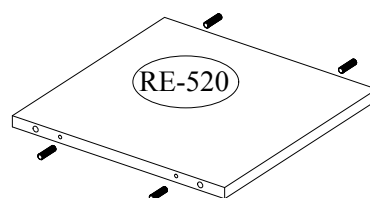

	8.0x30
B	D
4x2	4x4

**6**

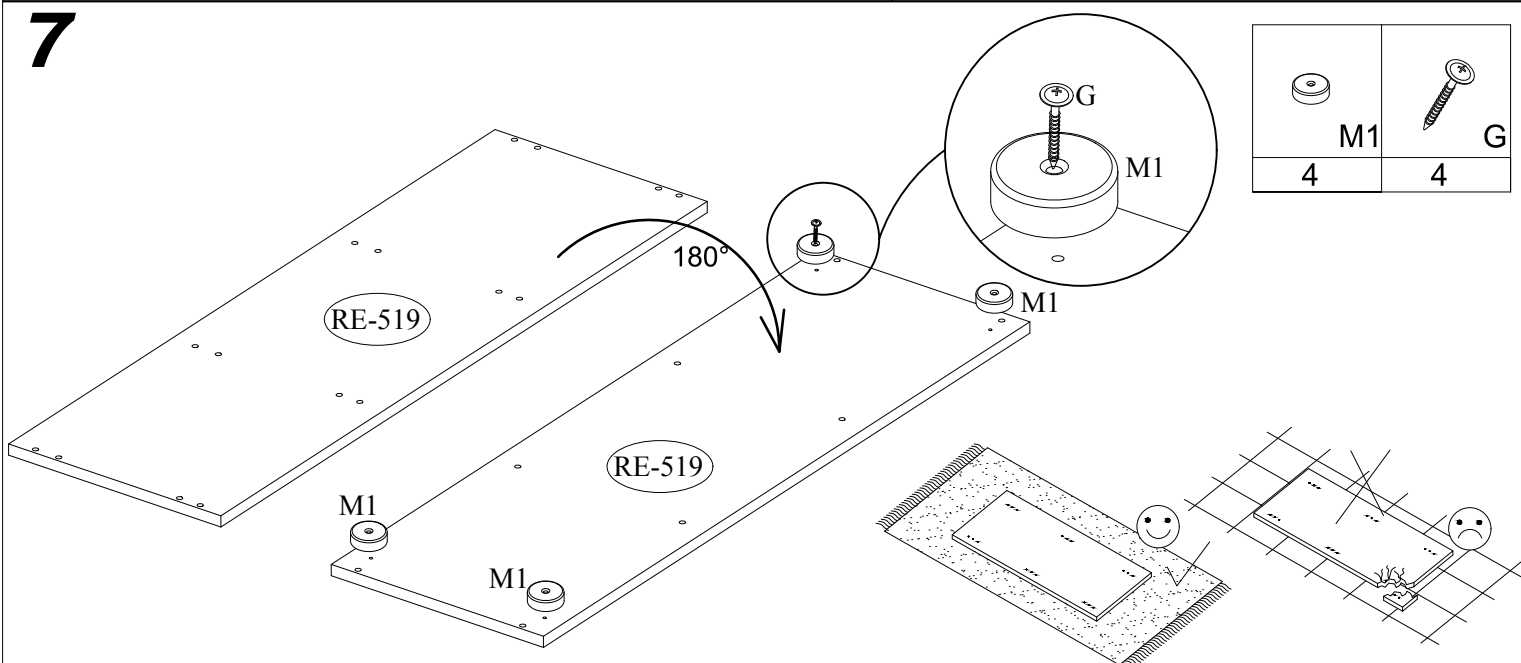
8.0x30	
	D
4	

**7**

M1	G
4	4

	A1		O
6			12

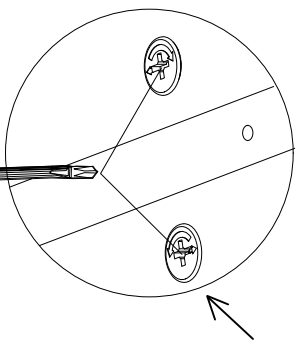
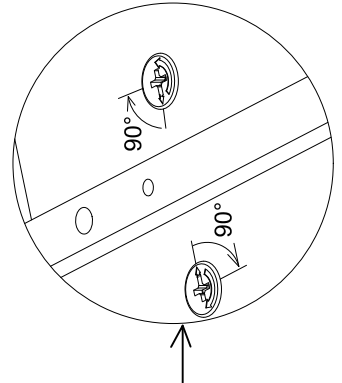
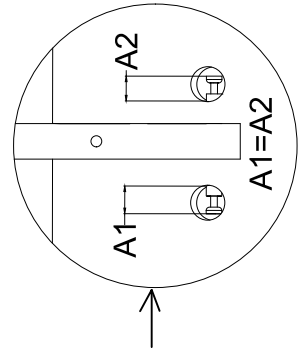
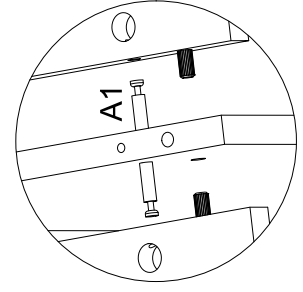
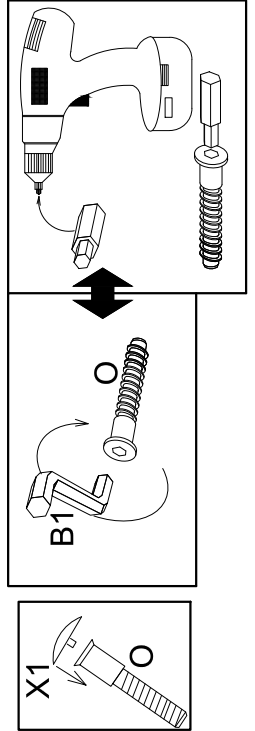
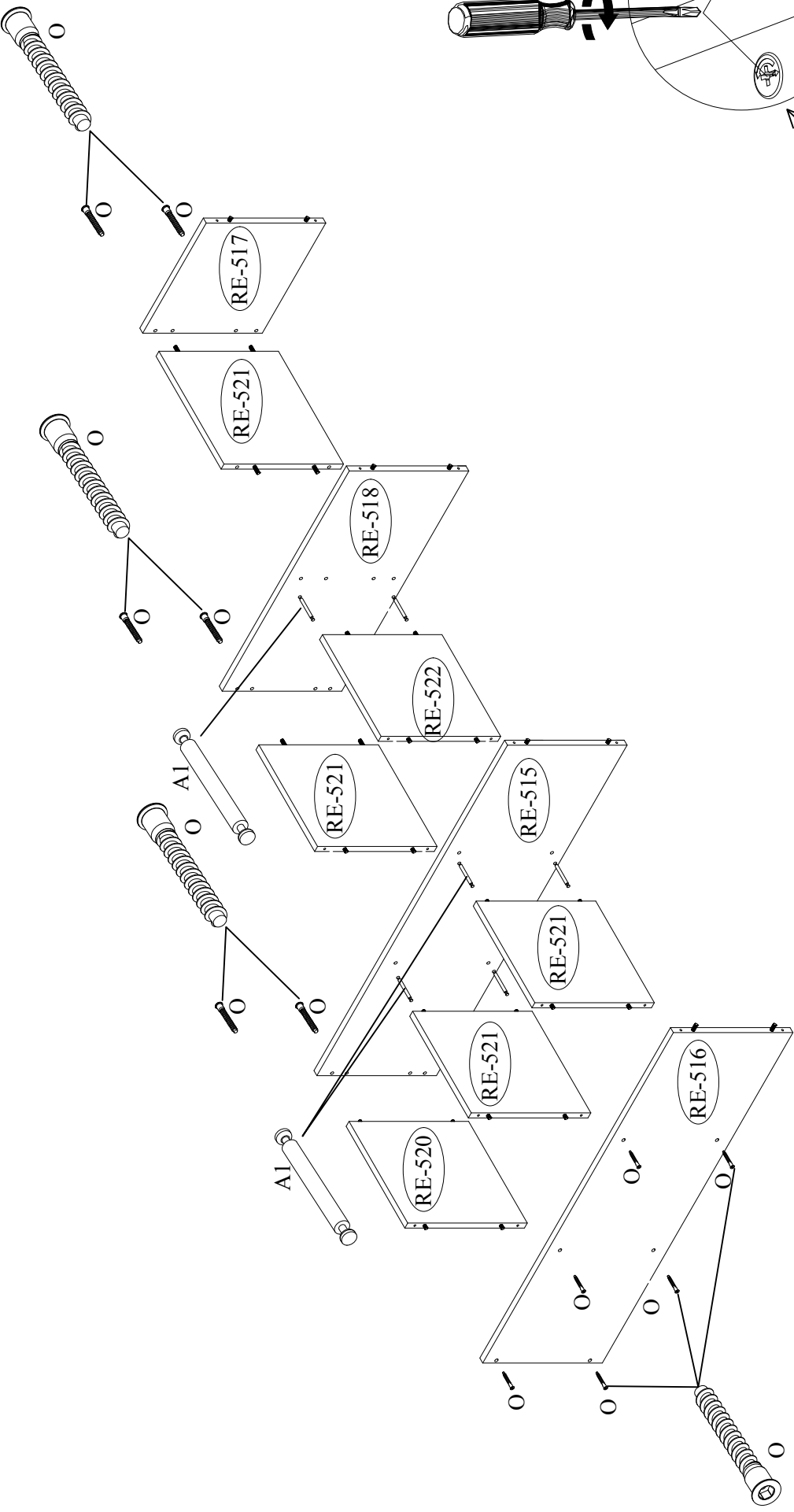

	○
	8

